

Computer Science & Engineering

Data Communication and Computer Networks

(MTCSE-101-A)

Transmission mode

```
graph TD; A[Transmission mode] --- B[Simplex]; A --- C[Half-duplex]; A --- D[Full-duplex]
```

Simplex

Half-duplex

Full-duplex

Simplex

Direction
of data

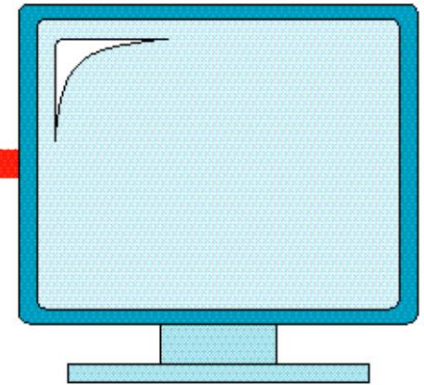
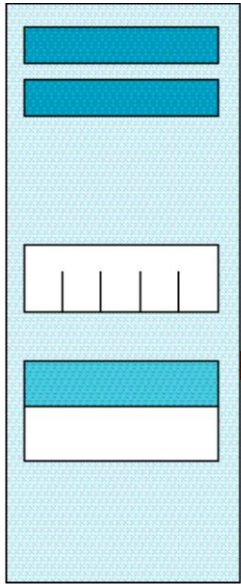

Mainframe

Monitor

Half-Duplex

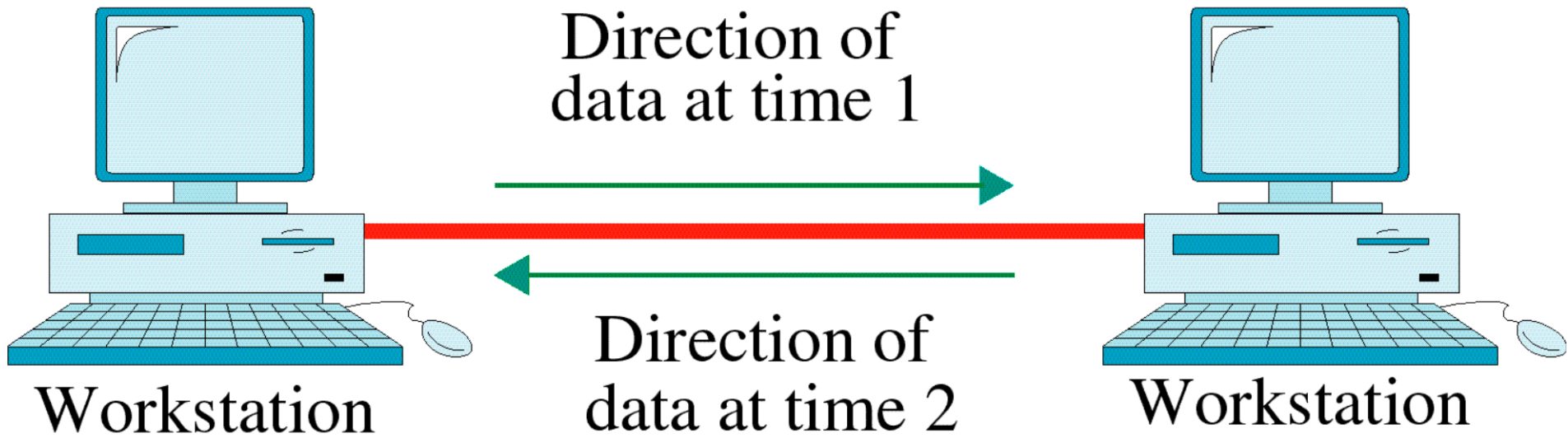

Full-Duplex

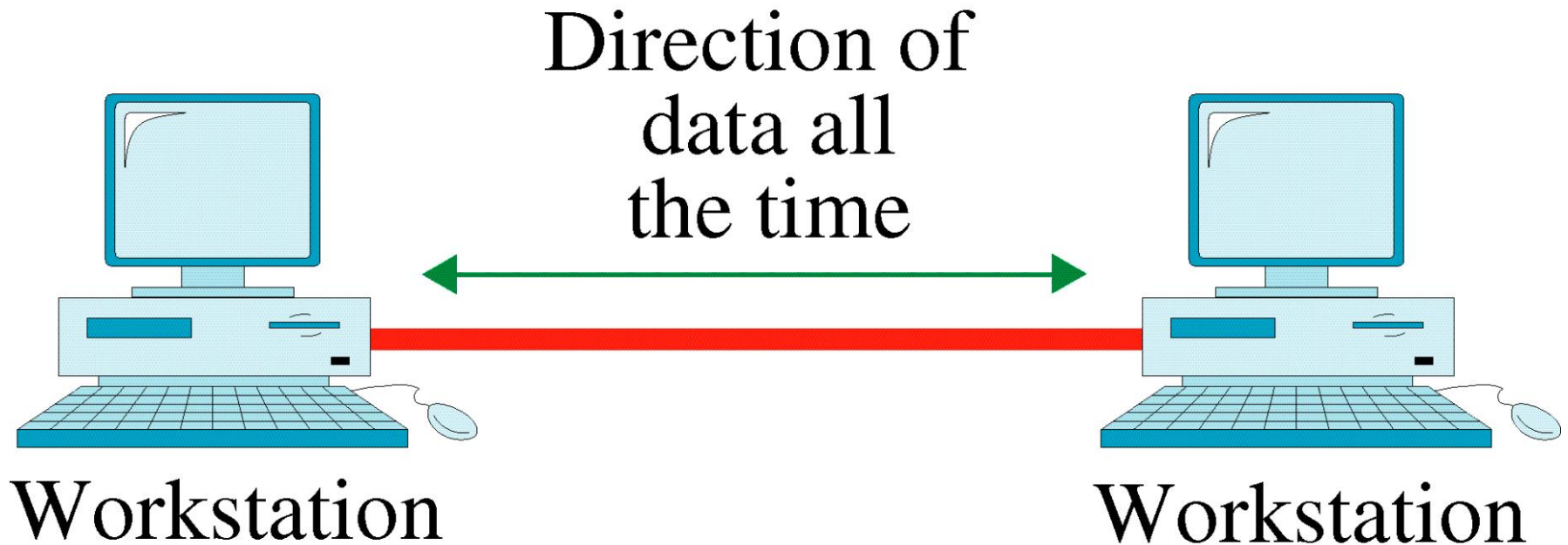

Network

```
graph TD; Network[Network] --- LAN[Local area network (LAN)]; Network --- MAN[Metropolitan area network (MAN)]; Network --- WAN[Wide area network (WAN)];
```

Local area
network
(LAN)

Metropolitan area
network
(MAN)

Wide area
network
(WAN)

Local Area Network

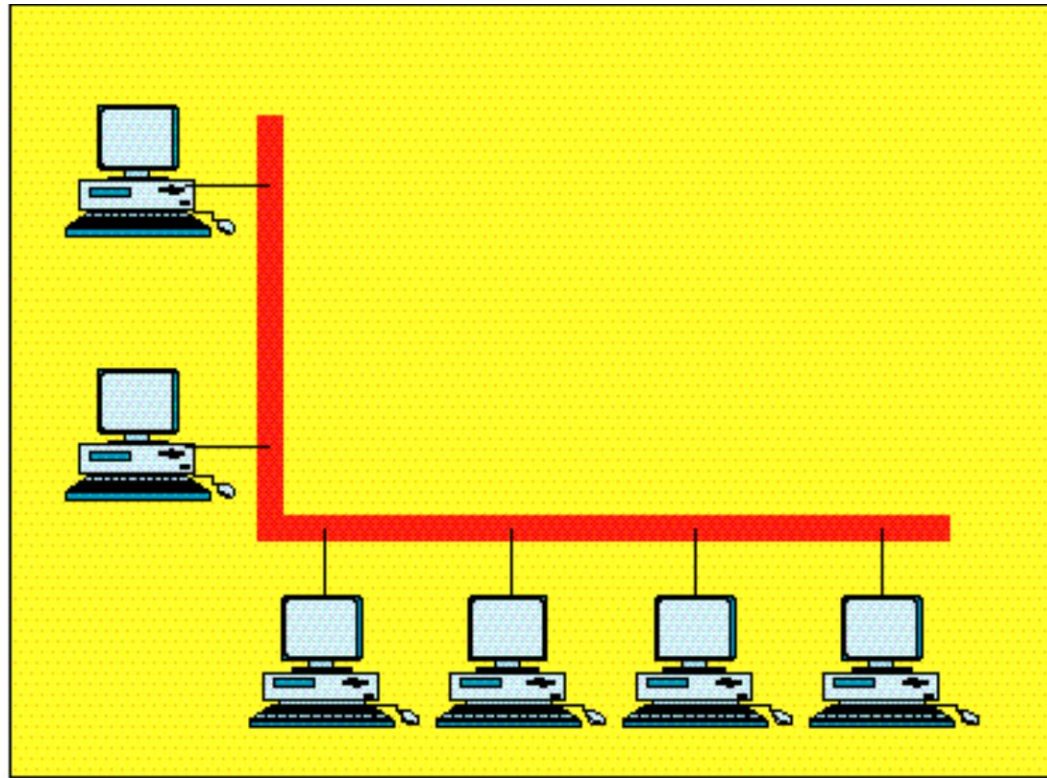

Single building LAN

Local Area Network

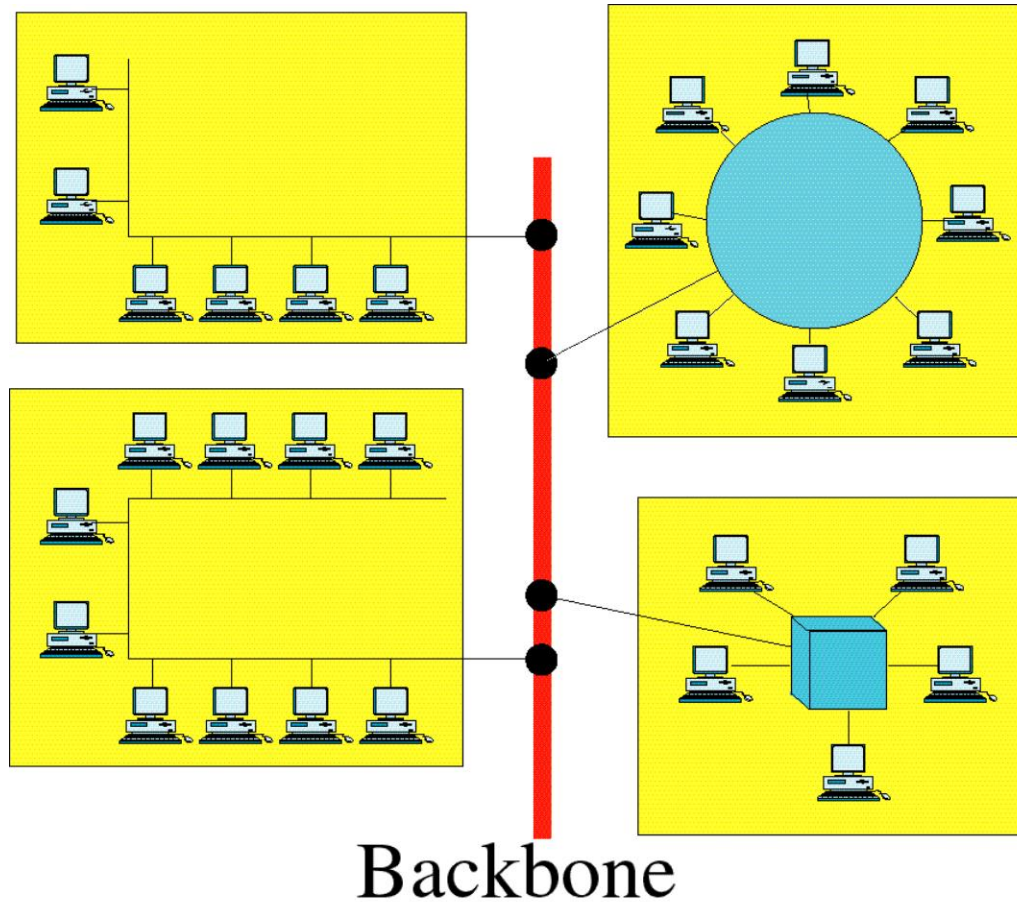

Multiple building LAN

Metropolitan Area Network

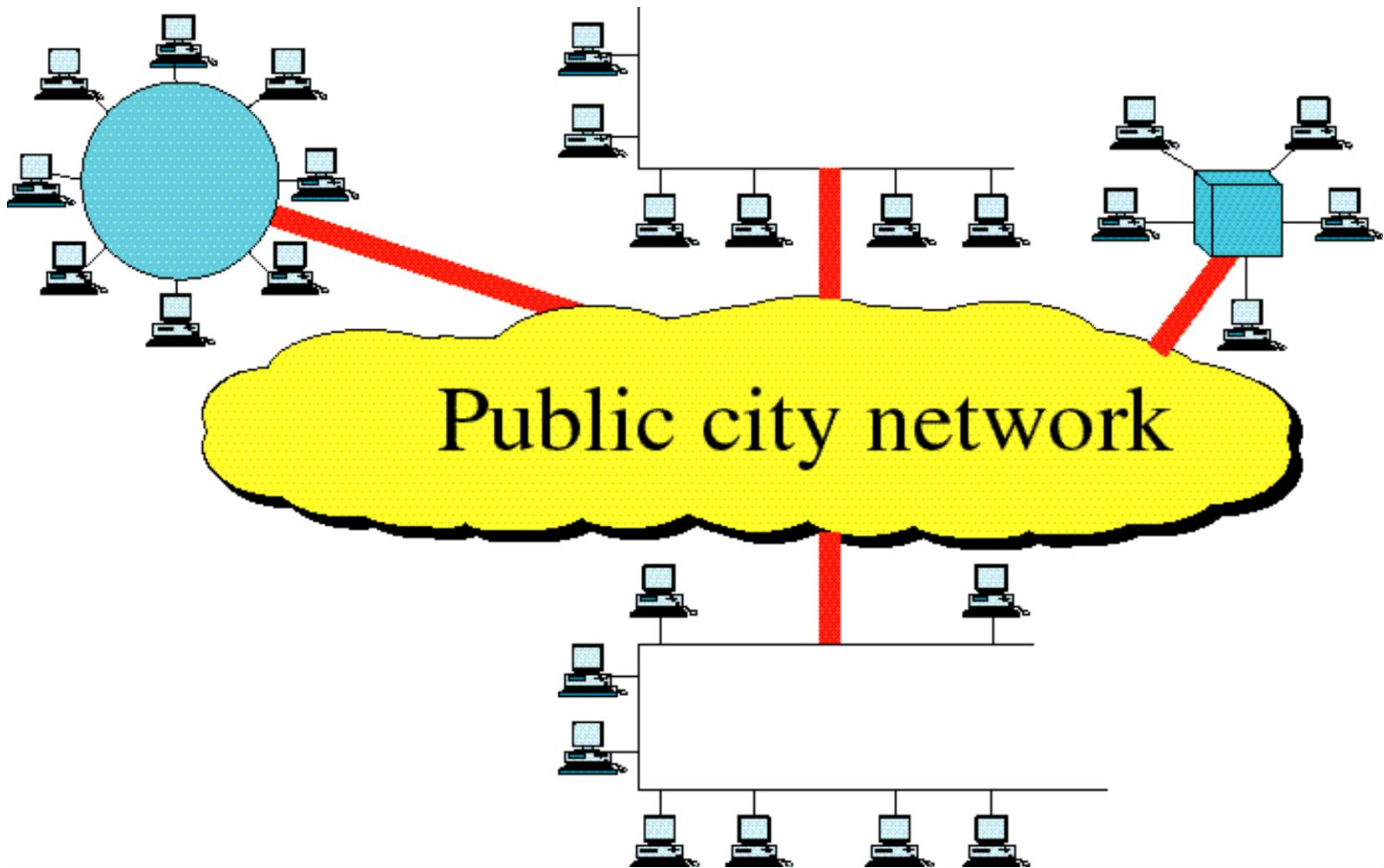

Wide Area Network

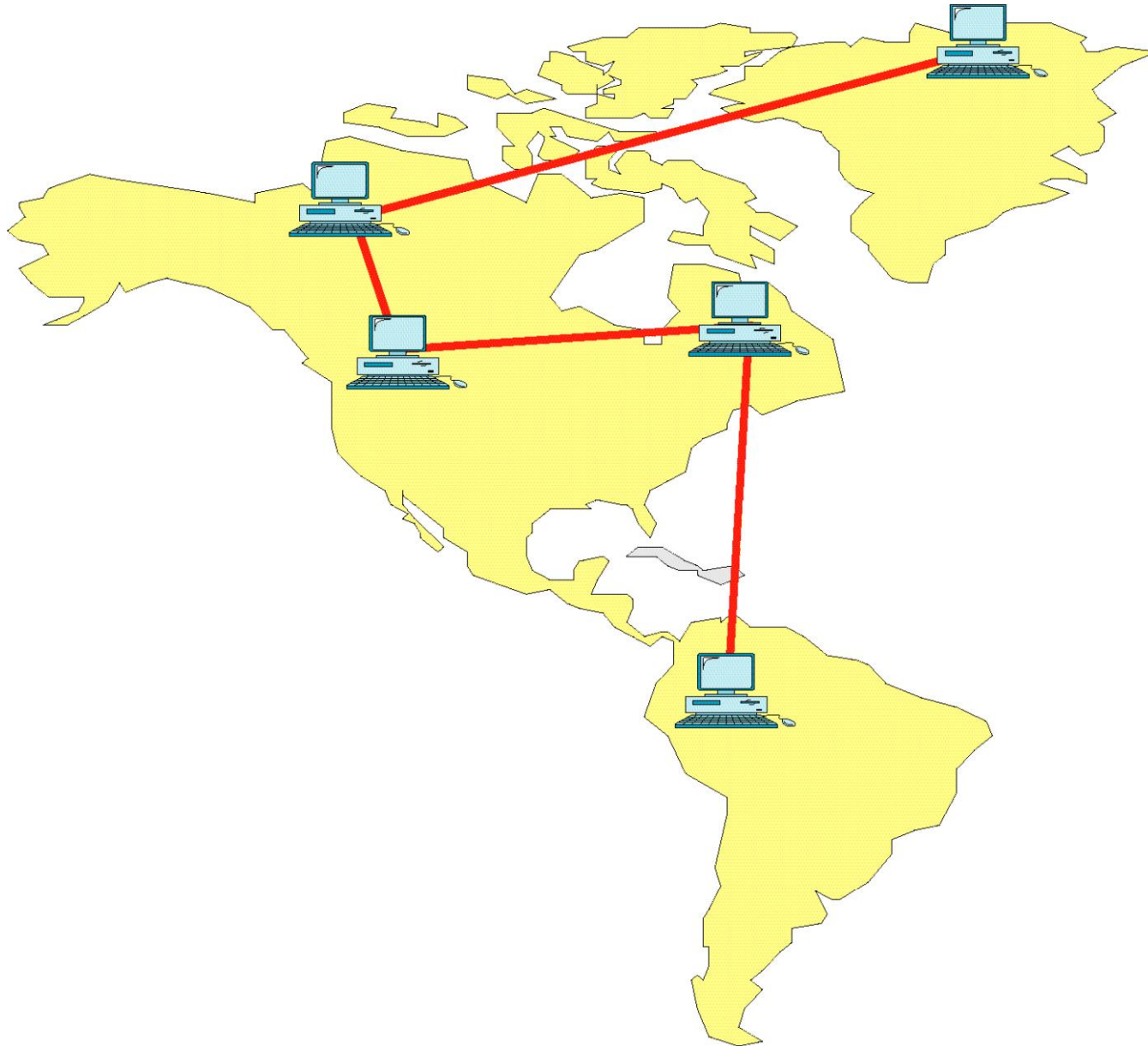

Internetwork (Internet)

